

Features

- **Low Voltage and Standard Voltage Operation**
 - 5.0 (V_{CC} = 4.5V to 5.5V)
 - 2.7 (V_{CC} = 2.7V to 5.5V)
 - 2.5 (V_{CC} = 2.5V to 5.5V)
 - 1.8 (V_{CC} = 1.8V to 5.5V)
- **Internally Organized 128 x 8 (1K), 256 x 8 (2K), 512 x 8 (4K), 1024 x 8 (8K) or 2048 x 8 (16K)**
- **2-Wire Serial Interface**
- **Bidirectional Data Transfer Protocol**
- **100 kHz (1.8V, 2.5V, 2.7V) and 400 kHz (5V) Compatibility**
- **Write Protect Pin for Hardware Data Protection**
- **8-Byte Page (1K, 2K), 16-Byte Page (4K, 8K, 16K) Write Modes**
- **Partial Page Writes Are Allowed**
- **Self-Timed Write Cycle (10 ms max)**
- **High Reliability**
 - Endurance: 1 Million Cycles
 - Data Retention: 100 Years
- **Automotive Grade and Extended Temperature Devices Available**
- **8-Pin and 14-Pin JEDEC SOIC and 8-Pin PDIP Packages**

Description

The AT24C01A/02/04/08/16 provides 1024/2048/4096/8192/16384 bits of serial electrically erasable and programmable read only memory (EEPROM) organized as 128/256/512/1024/2048 words of 8 bits each. The device is optimized for use in many industrial and commercial applications where low power and low voltage operation are essential. The AT24C01A/02/04/08/16 is available in space saving 8-pin PDIP, 8-pin and 14-pin SOIC packages and is accessed via a 2-wire serial interface. In addition, the entire family is available in 5.0V (4.5V to 5.5V), 2.7V (2.7V to 5.5V), 2.5V (2.5V to 5.5V) and 1.8V (1.8V to 5.5V) versions.

Pin Configurations

Pin Name	Function
A ₀ to A ₂	Address Inputs
SDA	Serial Data
SCL	Serial Clock Input
WP	Write Protect
NC	No Connect

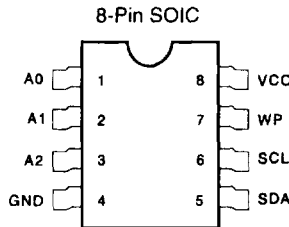
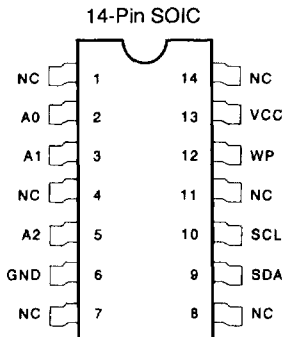
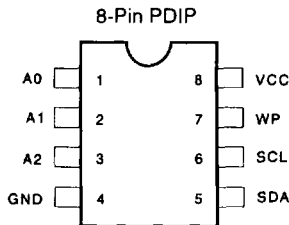

**2-Wire
Serial CMOS
E²PROM**

- 1K (128 x 8)
- 2K (256 x 8)
- 4K (512 x 8)
- 8K (1024 x 8)
- 16K (2048 x 8)





Absolute Maximum Ratings*

Operating Temperature.....	-55°C to +125°C
Storage Temperature.....	-65°C to +150°C
Voltage on Any Pin with Respect to Ground	-0.1V to +7.0V
Maximum Operating Voltage	6.25V
DC Output Current	5.0 mA

*NOTICE: Stresses beyond those listed under "Absolute Maximum Ratings" may cause permanent damage to the device. This is a stress rating only and functional operation of the device at these or any other conditions beyond those indicated in the operational sections of this specification is not implied. Exposure to absolute maximum rating conditions for extended periods may affect device reliability.

Block Diagram

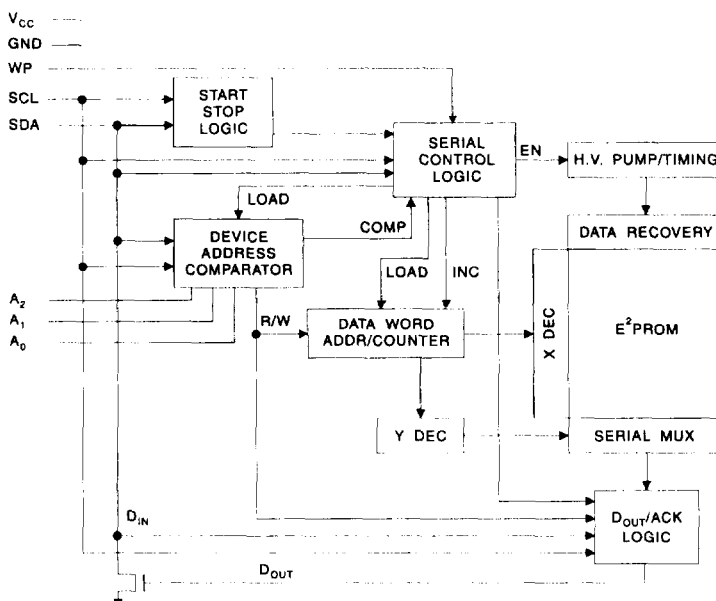

Pin Description

SERIAL CLOCK (SCL): The SCL input is used to positive edge clock data into each E²PROM device and negative edge clock data out of each device.

SERIAL DATA (SDA): The SDA pin is bidirectional for serial data transfer. This pin is open-drain driven and may be wire-ORed with any number of other open-drain or open collector devices.

DEVICE/PAGE ADDRESSES (A2, A1, A0): The A2, A1 and A0 pins are device address inputs that are hard wired for the AT24C01A and the AT24C02. As many as eight 1K/2K devices may be addressed on a single bus system (device addressing is discussed in detail under the Device Addressing section).

The AT24C04 uses the A2 and A1 inputs for hard wire addressing and a total of four 4K devices may be addressed on a single bus system. The A0 pin is a no connect.

The AT24C08 only uses the A2 input for hardwire addressing and a total of two 8K devices may be addressed on a single bus system. The A0 and A1 pins are no connects.

The AT24C16 does not use the device address pins which limits the number of devices on a single bus to one. The A0, A1 and A2 pins are no connects.

(continued)

Pin Description (Continued)

WRITE PROTECT (WP): The AT24C01A/02/04/16 has a Write Protect pin that provides hardware data protection. The Write Protect pin allows normal read/write operations when connected to ground (GND). When the Write Protect pin is connected to V_{CC}, the write protection feature is enabled and operates as shown in the following table.

WP Pin Status	Part of the Array Protected				
	24C01A	24C02	24C04	24C08	24C16
At V _{CC}	Full (1K) Array	Full (2K) Array	Full (4K) Array	Normal Read/Write Operation	Upper Half (8K) Array
At GND	Normal Read/Write Operations				

Memory Organization

AT24C01A, 1K SERIAL E²PROM: Internally organized with 128 pages of 1-byte each, the 1K requires a 7 bit data word address for random word addressing.

AT24C02, 2K SERIAL E²PROM: Internally organized with 256 pages of 1-byte each, the 2K requires an 8 bit data word address for random word addressing.

AT24C04, 4K SERIAL E²PROM: The 4K is internally organized with 256 pages of 2-bytes each. Random word addressing requires a 9 bit data word address.

AT24C08, 8K SERIAL E²PROM: The 8K is internally organized with 4 blocks of 256 pages of 4-bytes each. Random word addressing requires a 10 bit data word address.

AT24C16, 16K SERIAL E²PROM: The 16K is internally organized with 8 blocks of 256 pages of 8-bytes each. Random word addressing requires an 11 bit data word address.

2

Pin Capacitance ⁽¹⁾

Applicable over recommended operating range from T_A = 25°C, f = 1.0 MHz, V_{CC} = +1.8V.

Symbol	Test Condition	Max	Units	Conditions
C _{I/O}	Input/Output Capacitance (SDA)	8	pF	V _{I/O} = 0V
C _{IN}	Input Capacitance (A ₀ , A ₁ , A ₂ , SCL)	6	pF	V _{IN} = 0V

Note: 1. This parameter is characterized and is not 100% tested.

DC Characteristics

Applicable over recommended operating range from: T_{AI} = -40°C to +85°C, V_{CC} = +1.8V to +5.5V, T_{AC} = 0°C to +70°C, V_{CC} = +1.8V to +5.5V (unless otherwise noted).

Symbol	Parameter	Test Condition	Min	Typ	Max	Units
V _{CC1}	Supply Voltage		1.8		5.5	V
V _{CC2}	Supply Voltage		2.5		5.5	V
V _{CC3}	Supply Voltage		2.7		5.5	V
V _{CC4}	Supply Voltage		4.5		5.5	V
I _{CC}	Supply Current V _{CC} = 5.0V	READ at 100 kHz		0.4	1.0	mA
I _{CC}	Supply Current V _{CC} = 5.0V	WRITE at 100 kHz		2.0	3.0	mA
I _{SB1}	Standby Current V _{CC} = 1.8V	V _{IN} = V _{CC} or V _{SS}		0.6	3.0	μA
I _{SB2}	Standby Current V _{CC} = 2.5V	V _{IN} = V _{CC} or V _{SS}		1.4	4.0	μA
I _{SB3}	Standby Current V _{CC} = 2.7V	V _{IN} = V _{CC} or V _{SS}		1.6	4.0	μA
I _{SB4}	Standby Current V _{CC} = 5.0V	V _{IN} = V _{CC} or V _{SS}		8.0	18.0	μA
I _{LI}	Input Leakage Current	V _{IN} = V _{CC} or V _{SS}		0.10	3.0	μA
I _{LO}	Output Leakage Current	V _{OUT} = V _{CC} or V _{SS}		0.05	3.0	μA
V _{IL}	Input Low Level ⁽¹⁾		-1.0		V _{CC} x 0.3	V
V _{IH}	Input High Level ⁽¹⁾		V _{CC} x 0.7		V _{CC} + 0.5	V
V _{OL2}	Output Low Level V _{CC} = 3.0V	I _{OL} = 2.1 mA			0.4	V
V _{OL1}	Output Low Level V _{CC} = 1.8V	I _{OL} = 0.15 mA			0.2	V

Note: 1. V_{IL} min and V_{IH} max are reference only and are not tested.





AC Characteristics

Applicable over recommended operating range from $T_A = -40^{\circ}\text{C}$ to $+85^{\circ}\text{C}$, $V_{CC} = +1.8\text{V}$ to $+5.5\text{V}$, $CL = 1$ TTL Gate and 100 pF (unless otherwise noted).

Symbol	Parameter	2.7-, 2.5-, 1.8-volt		5.0-volt		Units
		Min	Max	Min	Max	
f_{SCL}	Clock Frequency, SCL		100		400	kHz
t_{LOW}	Clock Pulse Width Low	4.7		1.2		μs
t_{HIGH}	Clock Pulse Width High	4.0		0.6		μs
t_I	Noise Suppression Time ⁽¹⁾		100		50	ns
t_{AA}	Clock Low to Data Out Valid	0.1	4.5	0.1	0.9	μs
t_{BUF}	Time the bus must be free before a new transmission can start ⁽¹⁾	4.7		1.2		μs
$t_{HD,STA}$	Start Hold Time	4.0		0.6		μs
$t_{SU,STA}$	Start Set-up Time	4.7		0.6		μs
$t_{HD,DAT}$	Data In Hold Time	0		0		μs
$t_{SU,DAT}$	Data In Set-up Time	200		100		ns
t_R	Inputs Rise Time ⁽¹⁾		1.0		0.3	μs
t_F	Inputs Fall Time ⁽¹⁾		300		300	ns
$t_{SU,STO}$	Stop Set-up Time	4.7		0.6		μs
t_{DH}	Data Out Hold Time	100		50		ns
t_{WR}	Write Cycle Time		10		10	ms

Note: 1. This parameter is characterized and is not 100% tested.

Device Operation

CLOCK and DATA TRANSITIONS: The SDA pin is normally pulled high with an external device. Data on the SDA pin may change only during SCL low time periods (refer to Data Validity timing diagram). Data changes during SCL high periods will indicate a start or stop condition as defined below.

START CONDITION: A high-to-low transition of SDA with SCL high is a start condition which must precede any other command (refer to Start and Stop Definition timing diagram).

STOP CONDITION: A low-to-high transition of SDA with SCL high is a stop condition. After a read sequence, the stop command will place the E²PROM in a standby power mode (refer to Start and Stop Definition timing diagram).

ACKNOWLEDGE: All addresses and data words are serially transmitted to and from the E²PROM in 8 bit words. The E²PROM sends a zero to acknowledge that it has received each word. This happens during the ninth clock cycle.

STANDBY MODE: The AT24C01A/02/04/08/16 features a low power standby mode which is enabled: (a) upon power-up and (b) after the receipt of the STOP bit and the completion of any internal operations.

Bus Timing SCL: Serial Clock SDA: Serial Data I/O

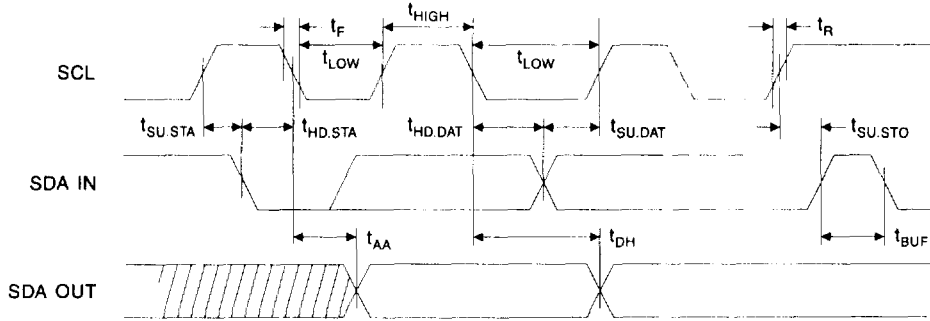

2

Write Cycle Timing SCL: Serial Clock SDA: Serial Data I/O

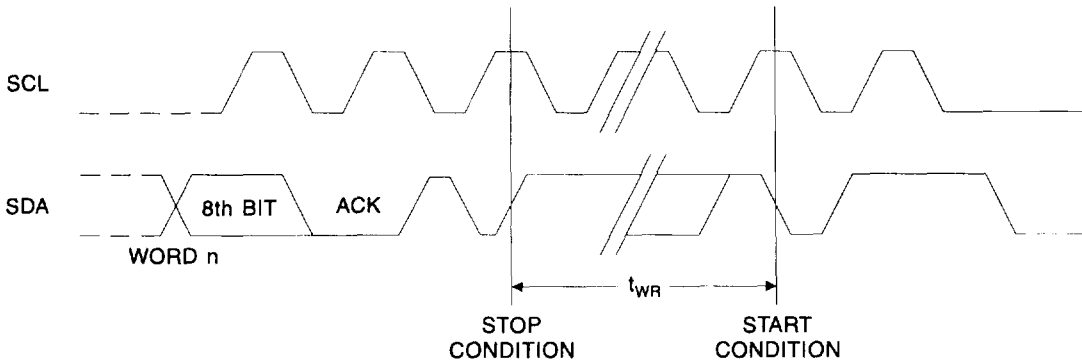

Note: 1. The write cycle time t_{WR} is the time from a valid stop condition of a write sequence to the end of the internal clear/write cycle.



Data Validity

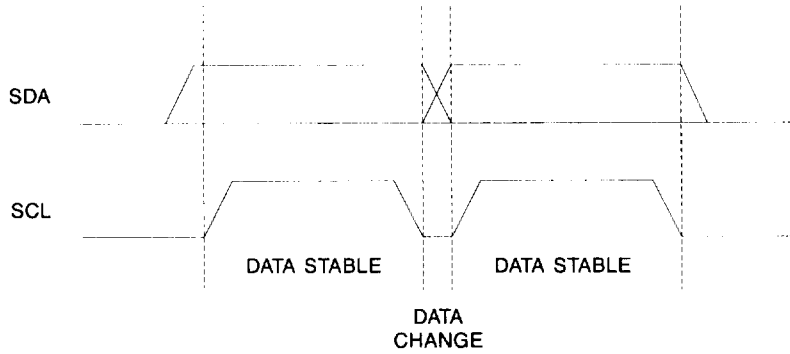

Start and Stop Definition

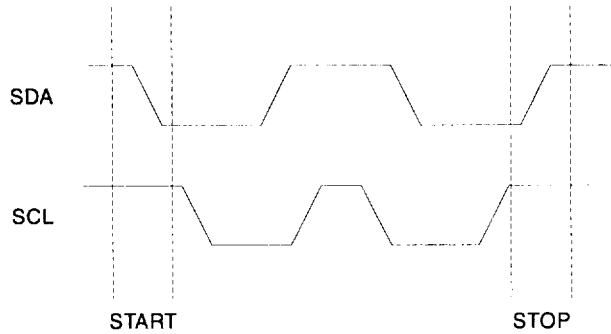

Output Acknowledge

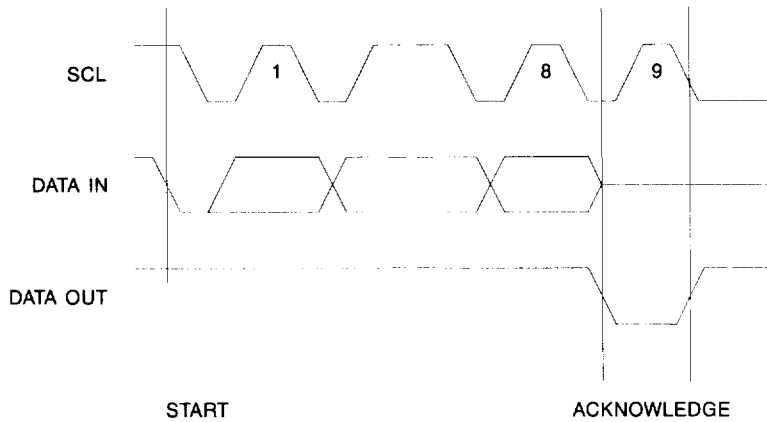

Device Addressing

The 1K, 2K, 4K, 8K and 16K E²PROM devices all require an 8 bit device address word following a start condition to enable the chip for a read or write operation (refer to Figure 1).

The device address word consists of a mandatory one, zero sequence for the first four most significant bits as shown. This is common to all the E²PROM devices.

The next 3 bits are the A2, A1 and A0 device address bits for the 1K/2K E²PROM. These 3 bits must compare to their corresponding hard-wired input pins.

The 4K E²PROM only uses the A2 and A1 device address bits with the third bit being a memory page address bit. The two device address bits must compare to their corresponding hard-wired input pins. The A0 pin is no connect.

The 8K E²PROM only uses the A2 device address bit with the next 2 bits being for memory page addressing. The A2 bit must compare to its corresponding hard-wired input pin. The A1 and A0 pins are no connect.

The 16K does not use any device address bits but instead the 3 bits are used for memory page addressing. These page addressing bits on the 4K, 8K, and 16K devices should be considered the most significant bits of the data word address which follows. The A0, A1 and A2 pins are no connect.

The eighth bit of the device address is the read/write operation select bit. A read operation is initiated if this bit is high and a write operation is initiated if this bit is low.

Upon a compare of the device address, the E²PROM will output a zero. If a compare is not made, the chip will return to a standby state.

Write Operations

BYTE WRITE: A write operation requires an 8 bit data word address following the device address word and acknowledgement. Upon receipt of this address, the E²PROM will again respond with a zero and then clock in the first 8 bit data word. Following receipt of the 8 bit data word, the E²PROM will output a zero and the addressing device, such as a microcontroller, must terminate the write sequence with a stop condition. At this time the E²PROM enters an internally-timed write cycle to the nonvolatile memory. All inputs are disabled during this write cycle and the E²PROM will not respond until the write is complete (refer to Figure 2).

PAGE WRITE: The 1K/2K E²PROM is capable of an 8-byte page write, and the 4K, 8K and 16K devices are capable of 16-byte page writes.

A page write is initiated the same as a byte write, but the microcontroller does not send a stop condition after the first data word is clocked in. Instead, after the E²PROM acknowledges receipt of the first data word, the microcontroller can transmit up to seven (1K/2K) or fifteen (4K, 8K, 16K) more data words. The E²PROM will respond with a zero after each data word received. The microcontroller must terminate the page write sequence with a stop condition (refer to Figure 3).

The data word address lower three (1K/2K) or four (4K, 8K, 16K) bits are internally incremented following the receipt of each data word. The higher data word address bits are not incremented, retaining the memory page row location. If more than eight (1K/2K) or sixteen (4K, 8K, 16K) data words are transmitted to the E²PROM, the data word address will "roll over" and previous data will be overwritten.

ACKNOWLEDGE POLLING: Once the internally-timed write cycle has started and the E²PROM inputs are disabled, acknowledge polling can be initiated. This involves sending a start condition followed by the device address word. The read/write bit is representative of the operation desired. Only if the internal write cycle has completed will the E²PROM respond with a zero allowing the read or write sequence to continue.

Read Operations

Read operations are initiated the same way as write operations with the exception that the read/write select bit in the device address word is set to one. There are three read operations: current address read, random address read and sequential read.

CURRENT ADDRESS READ: The internal data word address counter maintains the last address accessed during the last read or write operation, incremented by one. This address stays valid between operations as long as the chip power is maintained. The address "roll over" during read is from the last byte of the last memory page to the first byte of the first page. The address "roll over" during write is from the last byte of the current page to the first byte of the same page.

Once the device address with the read/write select bit set to one is clocked in and acknowledged by the E²PROM, the current address data word is serially clocked out. The microcontroller does not respond with an input zero but does generate a following stop condition (refer to Figure 4).

RANDOM READ: A random read requires a "dummy" byte write sequence to load in the data word address. Once the device address word and data word address are clocked in and acknowledged by the E²PROM, the micro-

(continued)



Read Operations (Continued)

controller must generate another start condition. The microcontroller now initiates a current address read by sending a device address with the read/write select bit high. The E²PROM acknowledges the device address and serially clocks out the data word. The microcontroller does not respond with a zero but does generate a following stop condition (refer to Figure 5).

SEQUENTIAL READ: Sequential reads are initiated by either a current address read or a random address read.

After the microcontroller receives a data word, it responds with an acknowledge. As long as the E²PROM receives an acknowledge, it will continue to increment the data word address and serially clock out sequential data words. When the memory address limit is reached, the data word address will "roll over" and the sequential read will continue. The sequential read operation is terminated when the microcontroller does not respond with a zero but does generate a following stop condition (refer to Figure 6).

Figure 1. Device Address

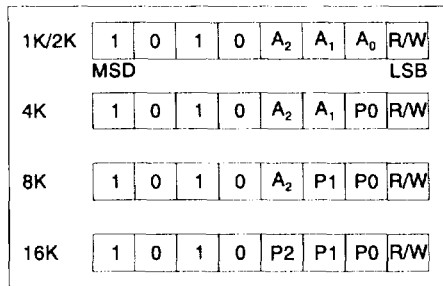

Figure 2. Byte Write

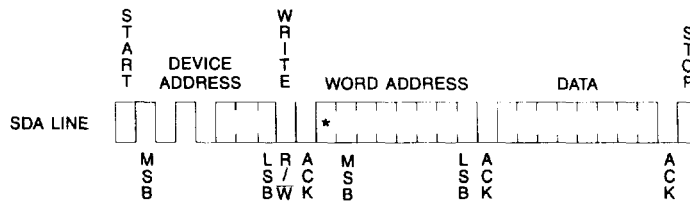

Figure 3. Page Write

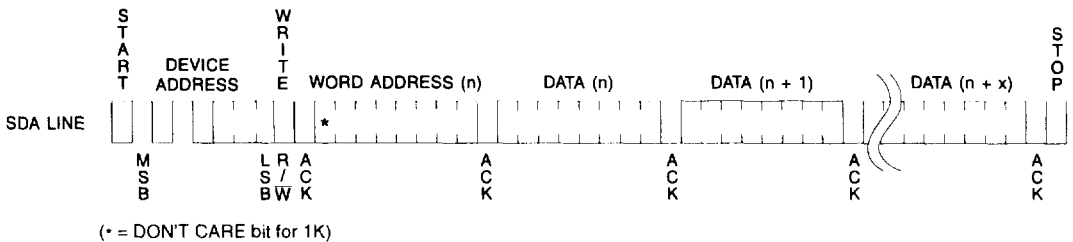
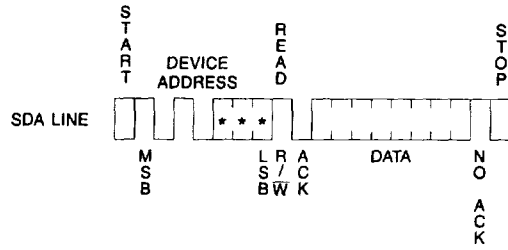
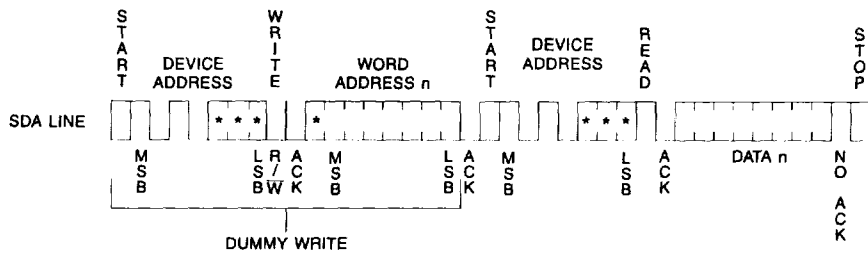

Figure 4. Current Address Read



2

Figure 5. Random Read



(* = DON'T CARE bit for 1K)

Figure 6. Sequential Read

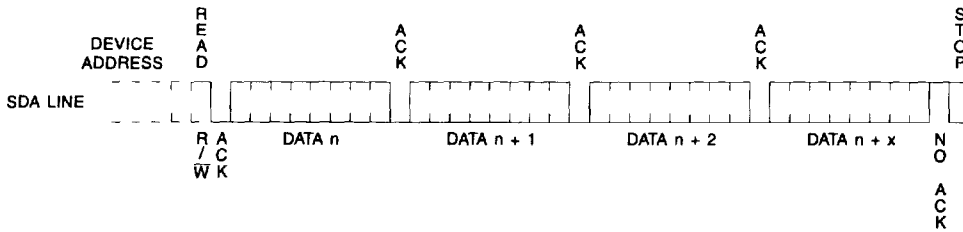



Ordering Information

t _{WR} (max) (ms)	I _{CC} (max) (μ A)	I _{SB} (max) (μ A)	f _{MAX} (kHz)	Ordering Code	Package	Operation Range
10	3000	18	400	AT24C01A-10PC AT24C01A-10SC	8P3 8S1	Commercial (0°C to 70°C)
	3000	18	400	AT24C01A-10PI AT24C01A-10SI	8P3 8S1	Industrial (-40°C to 85°C)
10	1500	4	100	AT24C01A-10PC-2.7 AT24C01A-10SC-2.7	8P3 8S1	Commercial (0°C to 70°C)
	1500	4	100	AT24C01A-10PI-2.7 AT24C01A-10SI-2.7	8P3 8S1	Industrial (-40°C to 85°C)
10	1000	4	100	AT24C01A-10PC-2.5 AT24C01A-10SC-2.5	8P3 8S1	Commercial (0°C to 70°C)
	1000	4	100	AT24C01A-10PI-2.5 AT24C01A-10SI-2.5	8P3 8S1	Industrial (-40°C to 85°C)
10	800	3	100	AT24C01A-10PC-1.8 AT24C01A-10SC-1.8	8P3 8S1	Commercial (0°C to 70°C)
	800	3	100	AT24C01A-10PI-1.8 AT24C01A-10SI-1.8	8P3 8S1	Industrial (-40°C to 85°C)

Package Type	
8P3	8 Lead, 0.300" Wide, Plastic Dual Inline Package (PDIP)
8S1	8 Lead, 0.150" Wide, Plastic Gull Wing Small Outline (JEDEC SOIC)
14S	14 Lead, 0.150" Wide, Plastic Gull Wing Small Outline (SOIC)
Options	
Blank	Standard Operation (4.5V to 5.5V)
-2.7	Low Voltage (2.7V to 5.5V)
-2.5	Low Voltage (2.5V to 5.5V)
-1.8	Low Voltage (1.8V to 5.5V)

Ordering Information

t _{WR} (max) (ms)	I _{CC} (max) (μA)	I _{SB} (max) (μA)	f _{MAX} (kHz)	Ordering Code	Package	Operation Range
10	3000	18	400	AT24C02-10PC AT24C02N-10SC AT24C02-10SC	8P3 8S1 14S	Commercial (0°C to 70°C)
	3000	18	400	AT24C02-10PI AT24C02N-10SI AT24C02-10SI	8P3 8S1 14S	Industrial (-40°C to 85°C)
10	1500	4	100	AT24C02-10PC-2.7 AT24C02N-10SC-2.7 AT24C02-10SC-2.7	8P3 8S1 14S	Commercial (0°C to 70°C)
	1500	4	100	AT24C02-10PI-2.7 AT24C02N-10SI-2.7 AT24C02-10SI-2.7	8P3 8S1 14S	Industrial (-40°C to 85°C)
10	1000	4	100	AT24C02-10PC-2.5 AT24C02N-10SC-2.5 AT24C02-10SC-2.5	8P3 8S1 14S	Commercial (0°C to 70°C)
	100	4	100	AT24C02-10PI-2.5 AT24C02N-10SI-2.5 AT24C02-10SI-2.5	8P3 8S1 14S	Industrial (-40°C to 85°C)
10	800	3	100	AT24C02-10PC-1.8 AT24C02N-10SC-1.8 AT24C02-10SC-1.8	8P3 8S1 14S	Commercial (0°C to 70°C)
	800	3	100	AT24C02-10PI-1.8 AT24C02N-10SI-1.8 AT24C02-10SI-1.8	8P3 8S1 14S	Industrial (-40°C to 85°C)

2

Package Type	
8P3	8 Lead, 0.300" Wide, Plastic Dual Inline Package (PDIP)
8S1	8 Lead, 0.150" Wide, Plastic Gull Wing Small Outline (JEDEC SOIC)
14S	14 Lead, 0.150" Wide, Plastic Gull Wing Small Outline (SOIC)
Options	
Blank	Standard Operation (4.5V to 5.5V)
-2.7	Low Voltage (2.7V to 5.5V)
-2.5	Low Voltage (2.5V to 5.5V)
-1.8	Low Voltage (1.8V to 5.5V)





Ordering Information

t _{WR} (max) (ms)	I _{CC} (max) (μA)	I _{SB} (max) (μA)	f _{MAX} (kHz)	Ordering Code	Package	Operation Range
10	3000	18	400	AT24C04-10PC AT24C04N-10SC AT24C04-10SC	8P3 8S1 14S	Commercial (0°C to 70°C)
	3000	18	400	AT24C04-10PI AT24C04N-10SI AT24C04-10SI	8P3 8S1 14S	Industrial (-40°C to 85°C)
10	1500	4	100	AT24C04-10PC-2.7 AT24C04N-10SC-2.7 AT24C04-10SC-2.7	8P3 8S1 14S	Commercial (0°C to 70°C)
	1500	4	100	AT24C04-10PI-2.7 AT24C04N-10SI-2.7 AT24C04-10SI-2.7	8P3 8S1 14S	Industrial (-40°C to 85°C)
10	1000	4	100	AT24C04-10PC-2.5 AT24C04N-10SC-2.5 AT24C04-10SC-2.5	8P3 8S1 14S	Commercial (0°C to 70°C)
	1000	4	100	AT24C04-10PI-2.5 AT24C04N-10SI-2.5 AT24C04-10SI-2.5	8P3 8S1 14S	Industrial (-40°C to 85°C)
10	800	3	100	AT24C04-10PC-1.8 AT24C04N-10SC-1.8 AT24C04-10SC-1.8	8P3 8S1 14S	Commercial (0°C to 70°C)
	800	3	100	AT24C04-10PI-1.8 AT24C04N-10SI-1.8 AT24C04-10SI-1.8	8P3 8S1 14S	Industrial (-40°C to 85°C)

Package Type	
8P3	8 Lead, 0.300" Wide, Plastic Dual Inline Package (PDIP)
8S1	8 Lead, 0.150" Wide, Plastic Gull Wing Small Outline (JEDEC SOIC)
14S	14 Lead, 0.150" Wide, Plastic Gull Wing Small Outline (SOIC)
Options	
Blank	Standard Operation (4.5V to 5.5V)
-2.7	Low Voltage (2.7V to 5.5V)
-2.5	Low Voltage (2.5V to 5.5V)
-1.8	Low Voltage (1.8V to 5.5V)

Ordering Information

tWR (max) (ms)	ICC (max) (μ A)	ISB (max) (μ A)	fMAX (kHz)	Ordering Code	Package	Operation Range
10	3000	18	400	AT24C08-10PC AT24C08N-10SC AT24C08-10SC	8P3 8S1 14S	Commercial (0°C to 70°C)
	3000	18	400	AT24C08-10PI AT24C08N-10SI AT24C08-10SI	8P3 8S1 14S	Industrial (-40°C to 85°C)
10	1500	4	100	AT24C08-10PC-2.7 AT24C08N-10SC-2.7 AT24C08-10SC-2.7	8P3 8S1 14S	Commercial (0°C to 70°C)
	1500	4	100	AT24C08-10PI-2.7 AT24C08N-10SI-2.7 AT24C08-10SI-2.7	8P3 8S1 14S	Industrial (-40°C to 85°C)
10	1000	4	100	AT24C08-10PC-2.5 AT24C08N-10SC-2.5 AT24C08-10SC-2.5	8P3 8S1 14S	Commercial (0°C to 70°C)
	1000	4	100	AT24C08-10PI-2.5 AT24C08N-10SI-2.5 AT24C08-10SI-2.5	8P3 8S1 14S	Industrial (-40°C to 85°C)
10	800	3	100	AT24C08-10PC-1.8 AT24C08N-10SC-1.8 AT24C08-10SC-1.8	8P3 8S1 14S	Commercial (0°C to 70°C)
	800	3	100	AT24C08-10PI-1.8 AT24C08N-10SI-1.8 AT24C08-10SI-1.8	8P3 8S1 14S	Industrial (-40°C to 85°C)

2

Package Type	
8P3	8 Lead, 0.300" Wide, Plastic Dual Inline Package (PDIP)
8S1	8 Lead, 0.150" Wide, Plastic Gull Wing Small Outline (JEDEC SOIC)
14S	14 Lead, 0.150" Wide, Plastic Gull Wing Small Outline (SOIC)
Options	
Blank	Standard Operation (4.5V to 5.5V)
-2.7	Low Voltage (2.7V to 5.5V)
-2.5	Low Voltage (2.5V to 5.5V)
-1.8	Low Voltage (1.8V to 5.5V)





Ordering Information

t _{WR} (max) (ms)	I _{CC} (max) (μ A)	I _{SB} (max) (μ A)	f _{MAX} (kHz)	Ordering Code	Package	Operation Range
10	3000	18	400	AT24C16-10PC AT24C16N-10SC AT24C16-10SC	8P3 8S1 14S	Commercial (0°C to 70°C)
	3000	18	400	AT24C16-10PI AT24C16N-10SI AT24C16-10SI	8P3 8S1 14S	Industrial (-40°C to 85°C)
10	1500	4	100	AT24C16-10PC-2.7 AT24C16N-10SC-2.7 AT24C16-10SC-2.7	8P3 8S1 14S	Commercial (0°C to 70°C)
	1500	4	100	AT24C16-10PI-2.7 AT24C16N-10SI-2.7 AT24C16-10SI-2.7	8P3 8S1 14S	Industrial (-40°C to 85°C)
10	1000	4	100	AT24C16-10PC-2.5 AT24C16N-10SC-2.5 AT24C16-10SC-2.5	8P3 8S1 14S	Commercial (0°C to 70°C)
	1000	4	100	AT24C16-10PI-2.5 AT24C16N-10SI-2.5 AT24C16-10SI-2.5	8P3 8S1 14S	Industrial (-40°C to 85°C)
10	800	3	100	AT24C16-10PC-1.8 AT24C16N-10SC-1.8 AT24C16-10SC-1.8	8P3 8S1 14S	Commercial (0°C to 70°C)
	800	3	100	AT24C16-10PI-1.8 AT24C16N-10SI-1.8 AT24C16-10SI-1.8	8P3 8S1 14S	Industrial (-40°C to 85°C)

Package Type	
8P3	8 Lead, 0.300" Wide, Plastic Dual Inline Package (PDIP)
8S1	8 Lead, 0.150" Wide, Plastic Gull Wing Small Outline (JEDEC SOIC)
14S	14 Lead, 0.150" Wide, Plastic Gull Wing Small Outline (SOIC)
Options	
Blank	Standard Operation (4.5V to 5.5V)
-2.7	Low Voltage (2.7V to 5.5V)
-2.5	Low Voltage (2.5V to 5.5V)
-1.8	Low Voltage (1.8V to 5.5V)